



عمران مدرن
بازار نوین ارتباطات ساختمانی

نصب آسانسور و تهیه کلیه قطعات

سراسر کشور



با قیمت استثنایی و اکیپ متخصص

برای مشاوره رایگان تماس بگیرید

02162999675

SHENYANG BLUELIGHT

沈阳蓝光，伴你飞翔
DRIVE THE FUTURE



- 南浔办事处
电话: 0572-3038853
Nanxun office
Tel: 0572-3038853
- 杭州办事处
电话: 13761969093
Hangzhou office
Tel: 13761969093
- 吴江办事处
电话: 0512-63222971
Wujiang office
Tel: 0512-63222971
- 外贸部
电话: 86-024-23780807-717, 86-024-83786420
邮箱: zhangruiyan@sylg.cn
FOREIGN TRADE CENTER
Tel: 86-024-23780807-717, 86-024-83786420
E-mail: zhangruiyan@sylg.cn
- 成都办事处
电话: 13940437228
Chengdu office
Tel: 13940437228
- 佛山办事处
电话: 13940069968
Foshan office
Tel: 13940069968
- 天津办事处
电话: 022-24432600
Tianjin office
Tel: 022-24432600
- 长沙办事处
电话: 18642018935
Changsha office
Tel: 18642018935
- 哈尔滨办事处
电话: 15998163725
Harbin office
Tel: 15998163725



[HTTP://WWW.SYLG.CN](http://www.sylg.cn)

2018年5月修订

沈阳蓝光驱动技术有限公司

电话 :024-23782971

传真 :024-23782973

024-23787939

地址 :沈阳市浑南新区世纪路 37 号

邮编 :110179

Shenyang Bluelight Drive Technology Co.,Ltd.

TEL:024-23782971 FAX:024-23782973 024-23787939

ADD:No.37 Shiji Road,hunnan New District,
Shenyang,China ZIP:110179

公司简介

- 沈阳蓝光集团成立于1989年，是专业从事电梯控制系统和永磁同步无齿轮电梯曳引机开发、生产的高科技企业。是中国电梯协会理事单位、ISO9001认证企业。
- 沈阳蓝光驱动技术有限公司在佛山及苏州均建有生产基地，其中佛山厂区5千平方米，年产2万台；苏州厂区1万平方米，年产3万台。
- 沈阳蓝光从1998年开始永磁同步无齿轮电梯曳引机产品的研制开发工作，组成了由两名电机学博士为主的课题组，投入大量人力、物力，先后同国内高校和国外知名企业开展技术合作，于2000年10月研制成功首台永磁同步无齿轮电梯曳引机并投入试运行。此后又经过多次重大技术、工艺改进，于2001年7月率先在国内通过国家电梯质量检测中心检验，并取得认证证书，产品投入批量生产。沈阳蓝光获得了永磁同步无齿轮电梯曳引机多项国家专利，拥有该项产品技术的全部自主知识产权。
- 到目前为止，蓝光集团生产的永磁同步无齿轮电梯曳引机产品在全国各地被广泛使用，部分产品远销到欧洲、美洲、韩国、日本、台湾、中东、东南亚等国家和地区。由于蓝光曳引机具有运行噪音低、振动小、运行舒适平稳等特点，深受广大电梯制造厂商的青睐。



About us

- Established in 1989, BlueLight is a leading manufacturer of elevator control systems and gearless permanent magnet synchronous machines. It is member of China Elevator Association and an enterprise certified by ISO9001.
- Shenyang BlueLight has also built production base in Foshan and Suzhou area. Foshan factory has floor space of 5,000 m² with annual production capacity 20,000 units. Suzhou factory has floor space of 10,000 m² with annual production capacity 30,000 units.
- From 1998, Shenyang BlueLight started development of gearless permanent magnet synchronous machines. With a R&D team leading by two doctors experts in motor, BlueLight cooperated constantly with domestic universities, overseas well-known companies for exchange of technology and successfully developed the first gearless permanent magnet synchronous machines in October, 2000. After several technical improvements, BlueLight passed the national EMC testing in July, 2001 and successfully obtained certification. Meanwhile, the machines had been launched into mass production. Shenyang BlueLight has granted several patents of gearless permanent magnet synchronous machines and owned all the knowledge property rights.
- Nowadays, BlueLight gearless machines are widely used in China and some of the products have been sold to Europe, America, Korea, Japan, Taiwan, Middle East, Southeast Asia etc. Relying on the excellent characteristics such as low noise, low vibration, smooth and comfortable running etc., BlueLight gearless machines are being recognized by more and more elevator manufacturers.

曳引机选型表

● **WYT-T**永磁同步曳引机
WYT-T PM TRACTION MACHINE

----- 01/04

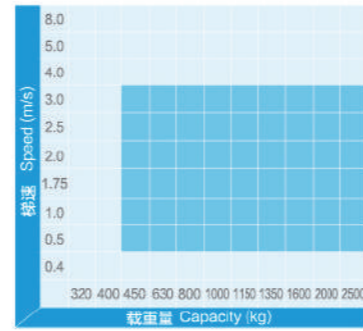

● **WYT-L**永磁同步曳引机
WYT-L PM TRACTION MACHINE

----- 05/06

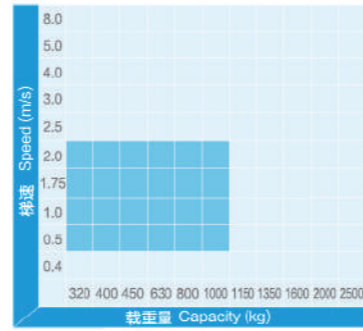

● **WYT-U**永磁同步曳引机
WYT-U PM TRACTION MACHINE

----- 07/08

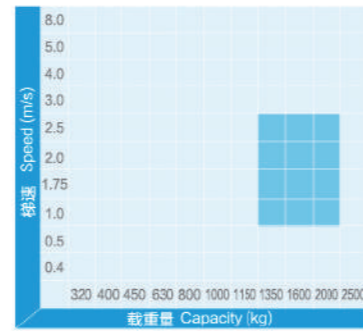

● **WYT-V**永磁同步曳引机(1:1悬挂比)
WYT-V PM TRACTION MACHINE(1:1 ROPING)

----- 09/10

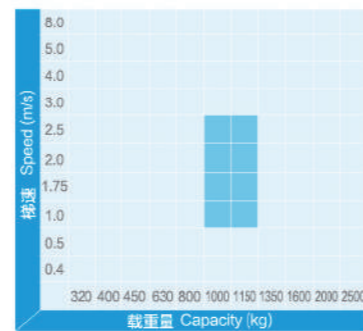

● **WYT-S**永磁同步曳引机
WYT-S PM TRACTION MACHINE

----- 11/12

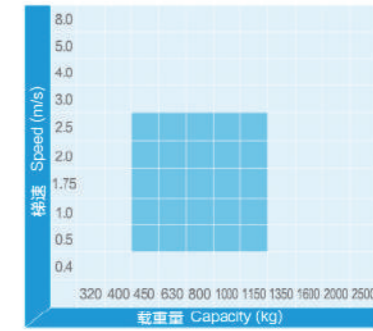

● **WYT-H**永磁同步曳引机
WYT-H PM TRACTION MACHINE

----- 13/14

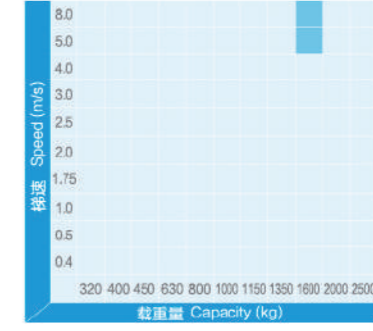

● **WYT-FD**永磁同步曳引机(钢带别墅梯)
WYT-FD PM TRACTION MACHINE(BELT VILLA)

----- 15/16

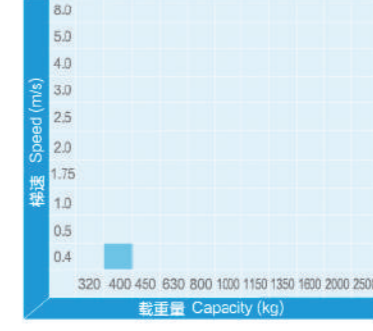

● **WYT-Y**永磁同步曳引机
WYT-Y PM TRACTION MACHINE

----- 17/19

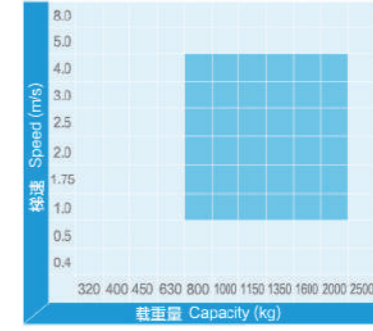

MACHINE TYPE RECOMMENDATION TABLE

WYT-T

永磁同步曳引机

PM Traction Machine

WYT-T系列是我司主力推出的经典款外转子永磁同步曳引机。此系列经过10余年的不断改善，产品质量非常稳定，性能指标国内领先，产品覆盖范围极广，成为现在高性能电梯的首选产品。

WYT-T series outer rotor PMS machine is Blueight's most popular product. After 10 years of continuous improvement, this series product has high quality standard, with superior performance, and can cover wide range of elevator application. It is your first choice for high performance elevator.



主机技术参数 (Parameter of Traction Machine)

额定电压 (Voltage) : AC380V
 悬挂比 (Roping) : 2: 1
 钢丝绳绕法 (Wrap) : 单绕 (Single)
 额定载重量 (Capacity) : 450kg ~ 2500kg
 轿厢速度 (Speed) : 0.5m/s ~ 3.0m/s
 防护等级 (Protection Grade) : IP41
 绝缘等级 (Ins. Class) : F
 曳引机极数 (Traction machine pole):
 轴负荷 (Shaft Load) 2500kg ~ 3500kg: 20
 轴负荷 (Shaft Load) 5500kg ~ 7500kg: 30
 启动频次 (次/小时, Stars per hour): 240
 工作制 (Rating): S5-40%
 推荐提升高度 (Height):
 轴负荷 (Shaft Load) 2500kg ~ 3500kg ≤ 90m
 轴负荷 (Shaft Load) 5500kg ~ 7500kg ≤ 120m

特点 (Features)

- 合理的机械结构设计，轴负荷大，运行安全系数高；
- 高效率、高转矩密度设计，优化的极槽配合；
- 主机运行平稳，噪音低，振动小；
- 轿厢速度、载重量覆盖广；
- 采用无闸臂块式制动器，响应快，可靠性高。
- Optimized mechanical structure design, high shaft load, high operating safety factor;
- High efficiency, high torque density design and optimized pole slot coordination;
- Machine run smoothly, with low noise & small vibration;
- This series covers wide range of elevator speed & capacity.
- Use block type armless brake, it has fast response time & high reliability.

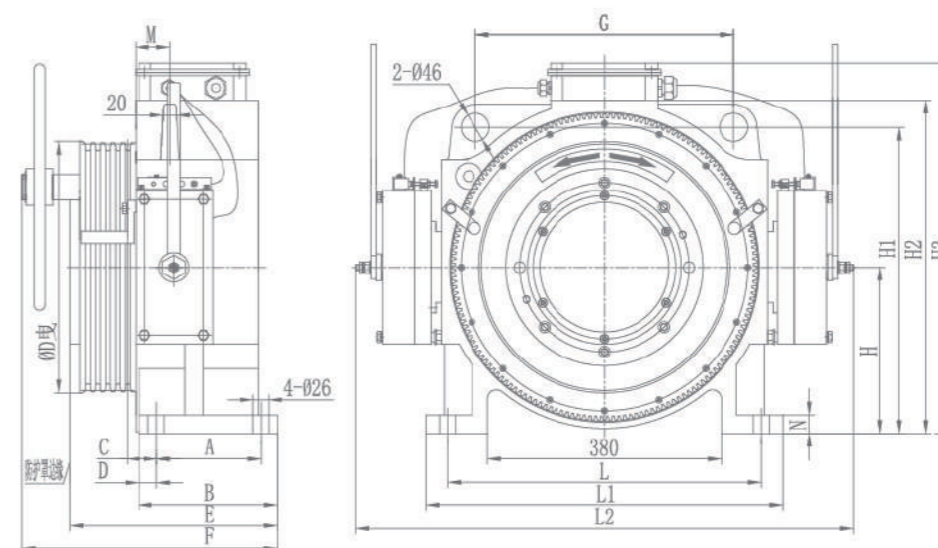

外观尺寸图 | Outline drawing

制动器技术参数 (Parameter of Brake)

型号 (Model) : BLB 绝缘等级 (Ins. Class) : F 额定电压 (Voltage) : DC110V
 额定电流 (Current) :

系列 Series	型号 Model	梯速 (m/s) Speed	载重代号 Capacity code	额定电流 Current
WYT-T		0.5~2.0	A, B, AL (450kg~630kg)	1.1A
			C, D, E, BL, CL, DL (630kg~1150kg)	1.3A
	E	0.5~3.0	DL, EL (1000kg~1150kg)	1.6A
		0.5~2.0	C, D, E, F (1275kg~2000kg)	
		0.5~3.0	CL, DL, EL (1275kg~1600kg)	
		0.5~2.0	G (2500kg)	1.98A
0.5~3.0	FL (2000kg)			

